

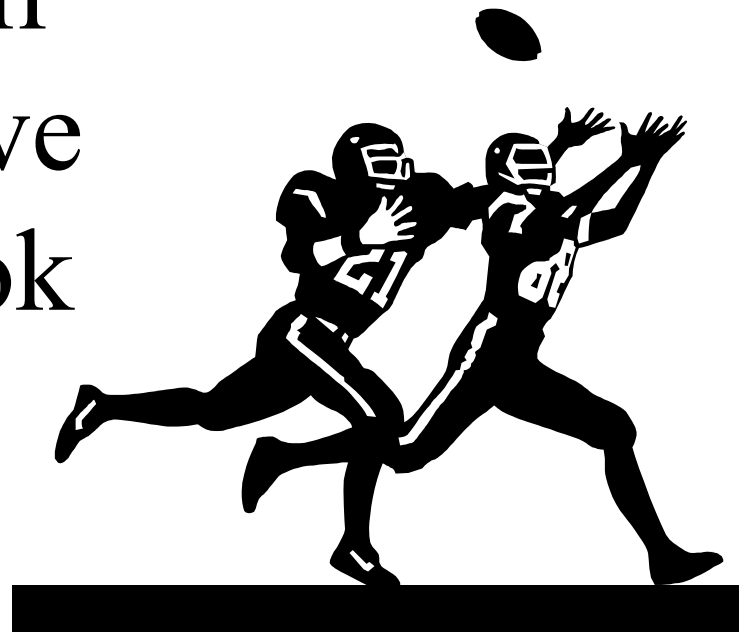

2007
Everest Charger
Football
Offensive
Playbook

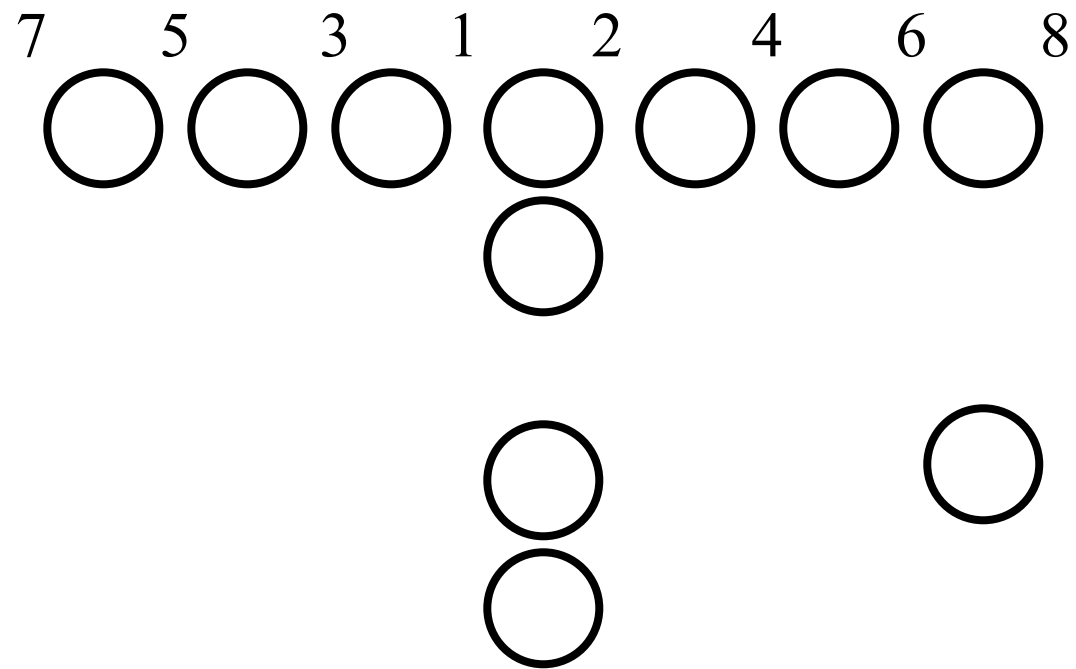

Line Hole Numbers



Positions

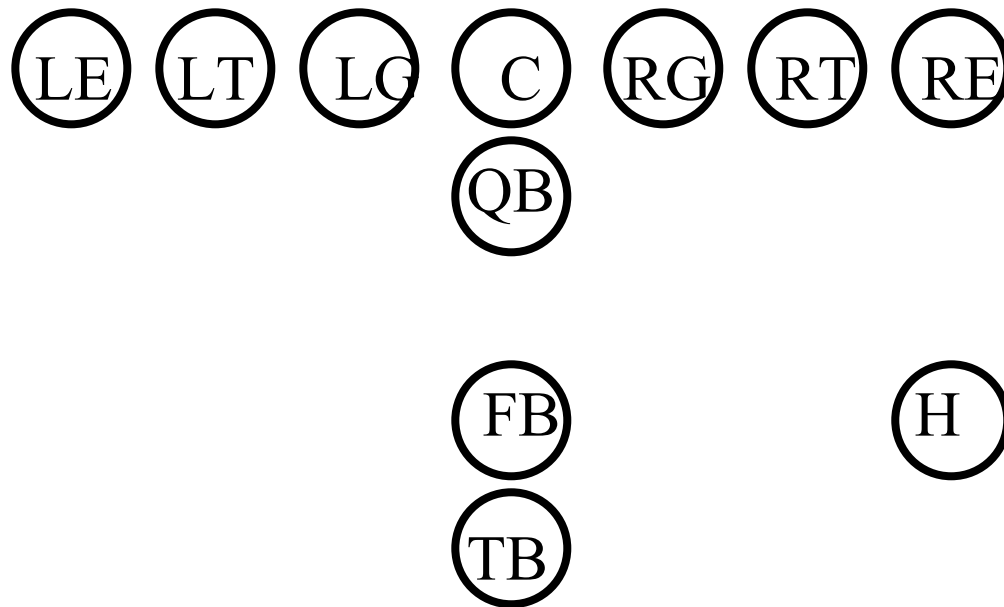

LE – Left End

LT - Left Tackle

LG – Left Guard

C – Center

RG – Right Guard

RT – Right Tackle

RE – Right End

QB – Quarterback

FB – Fullback

TB – Tailback

H - H Back

Line Splits

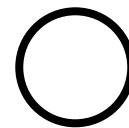
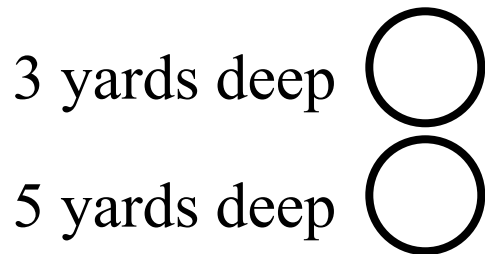
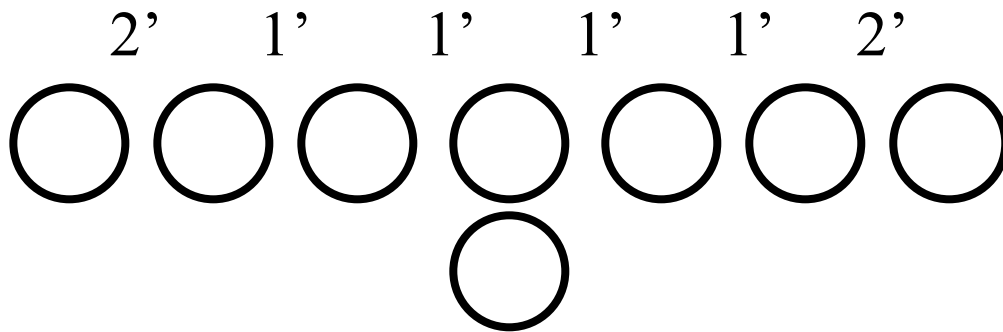

Even with FB
Directly behind
TE
Either Side

Pass Routes

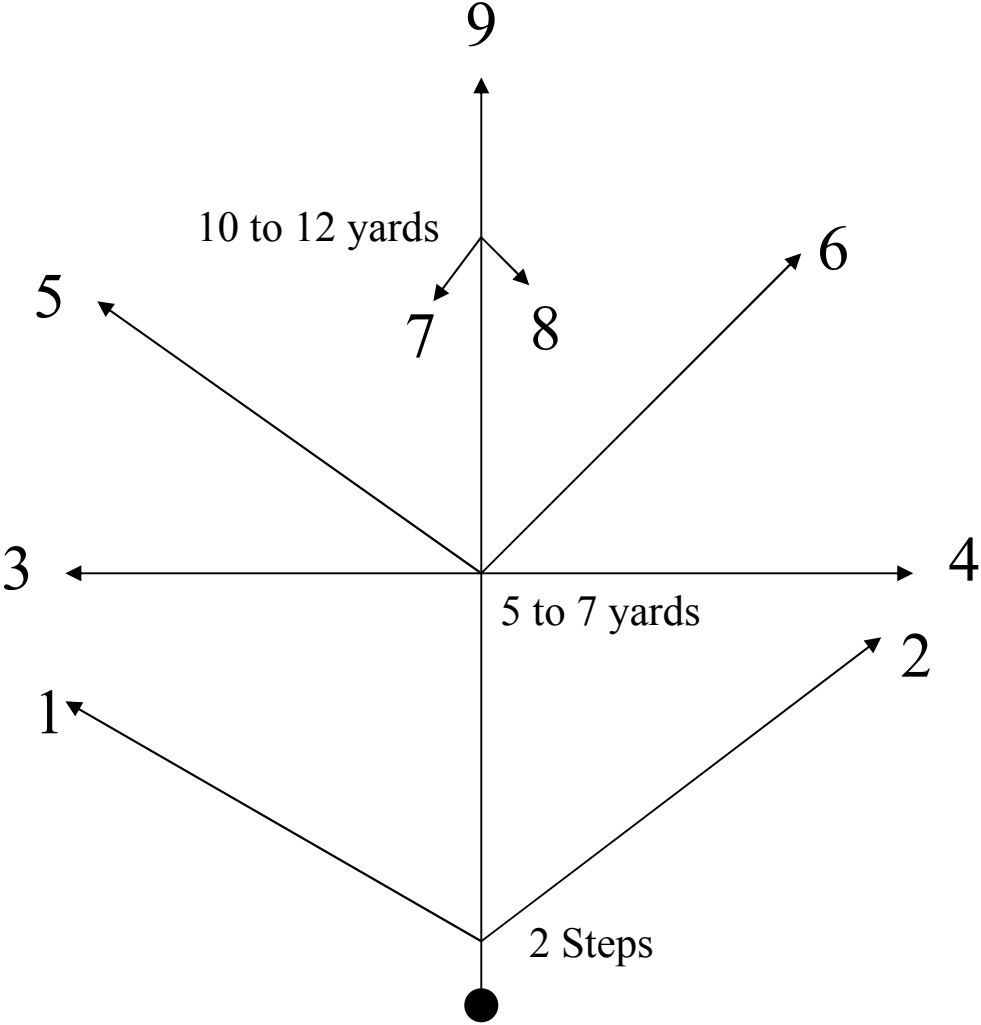

10 Series

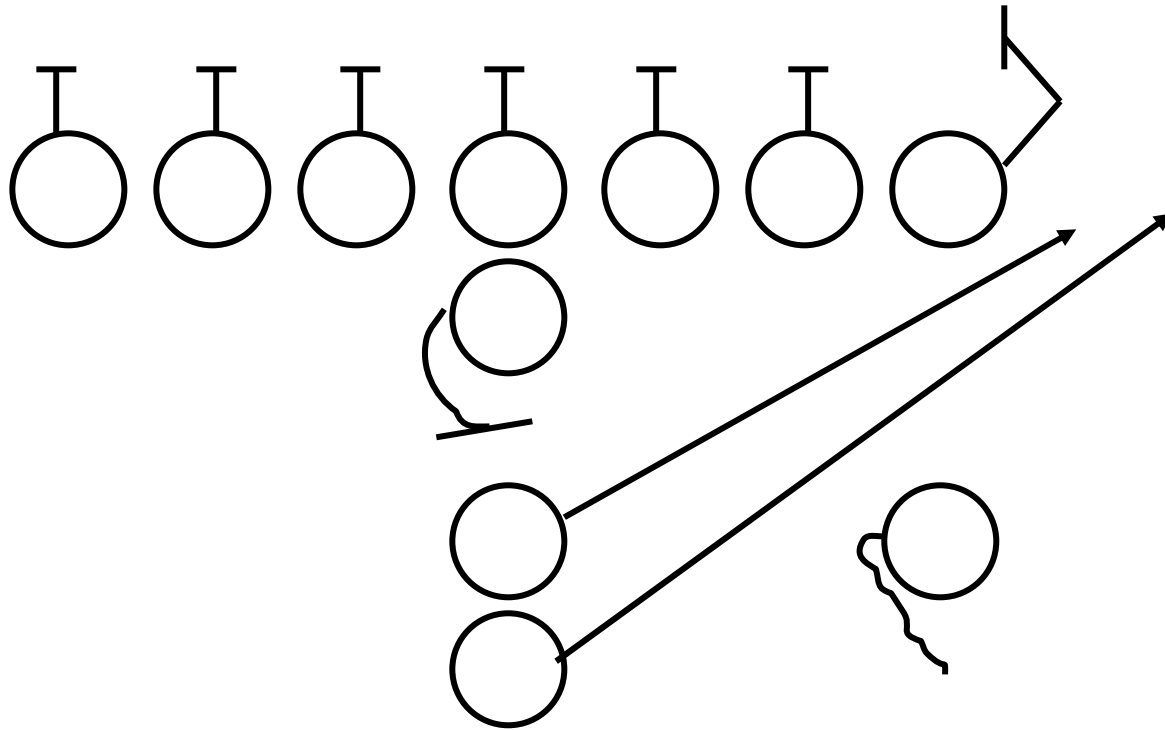

10 Screen

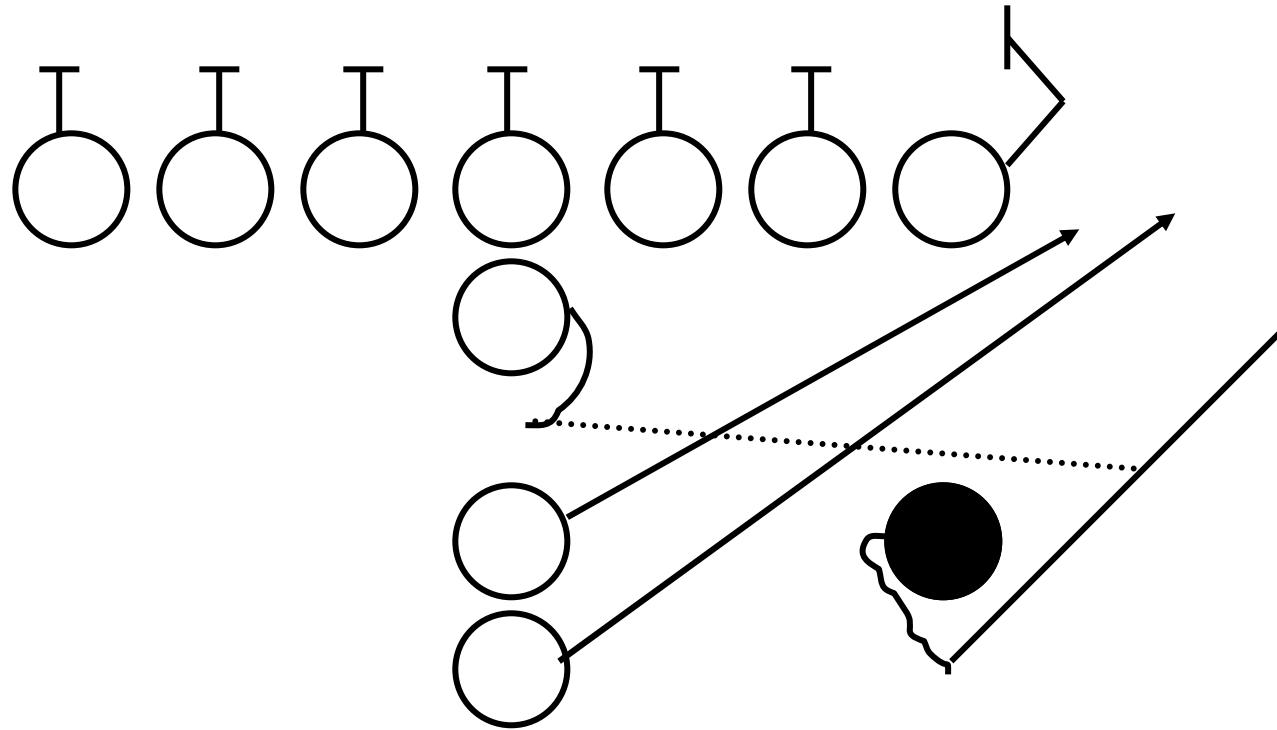

10 Tight

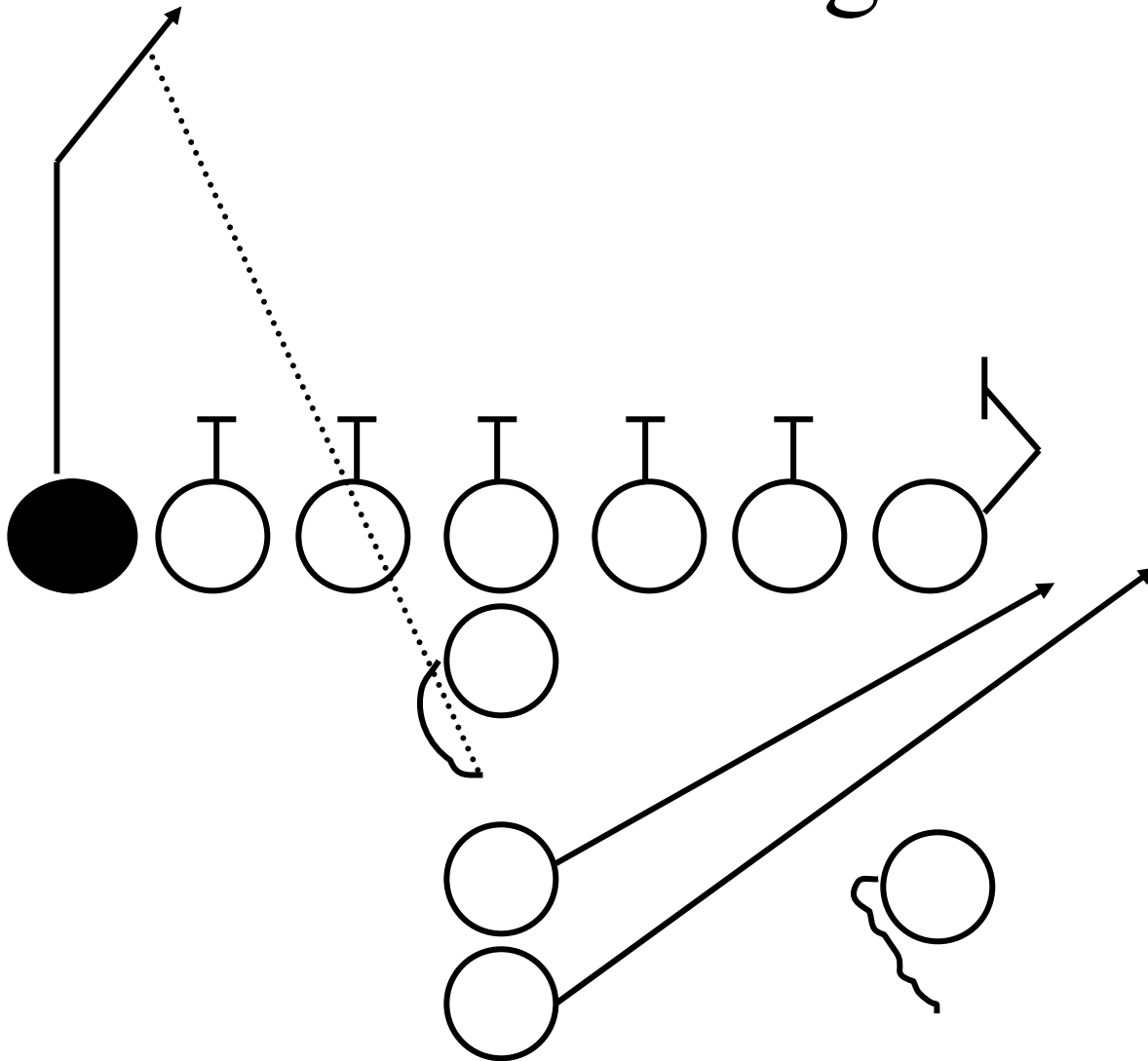

10 Draw

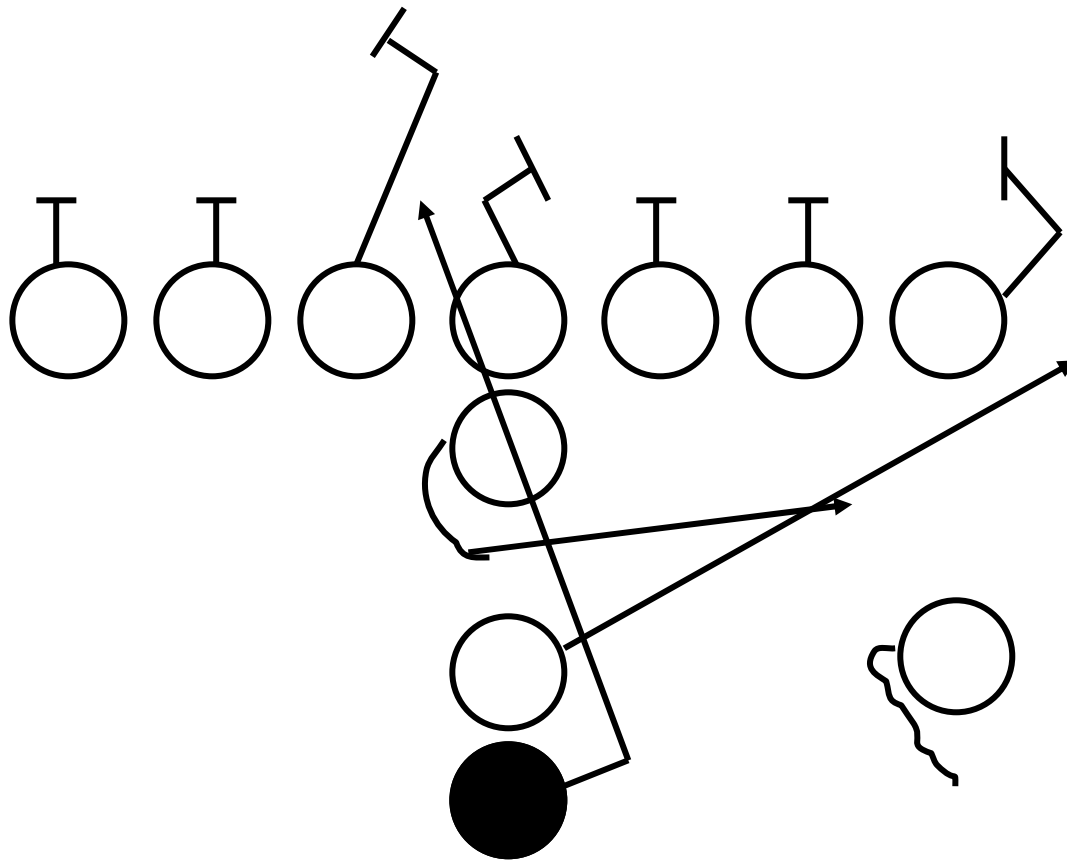

10 Flip

20 Series

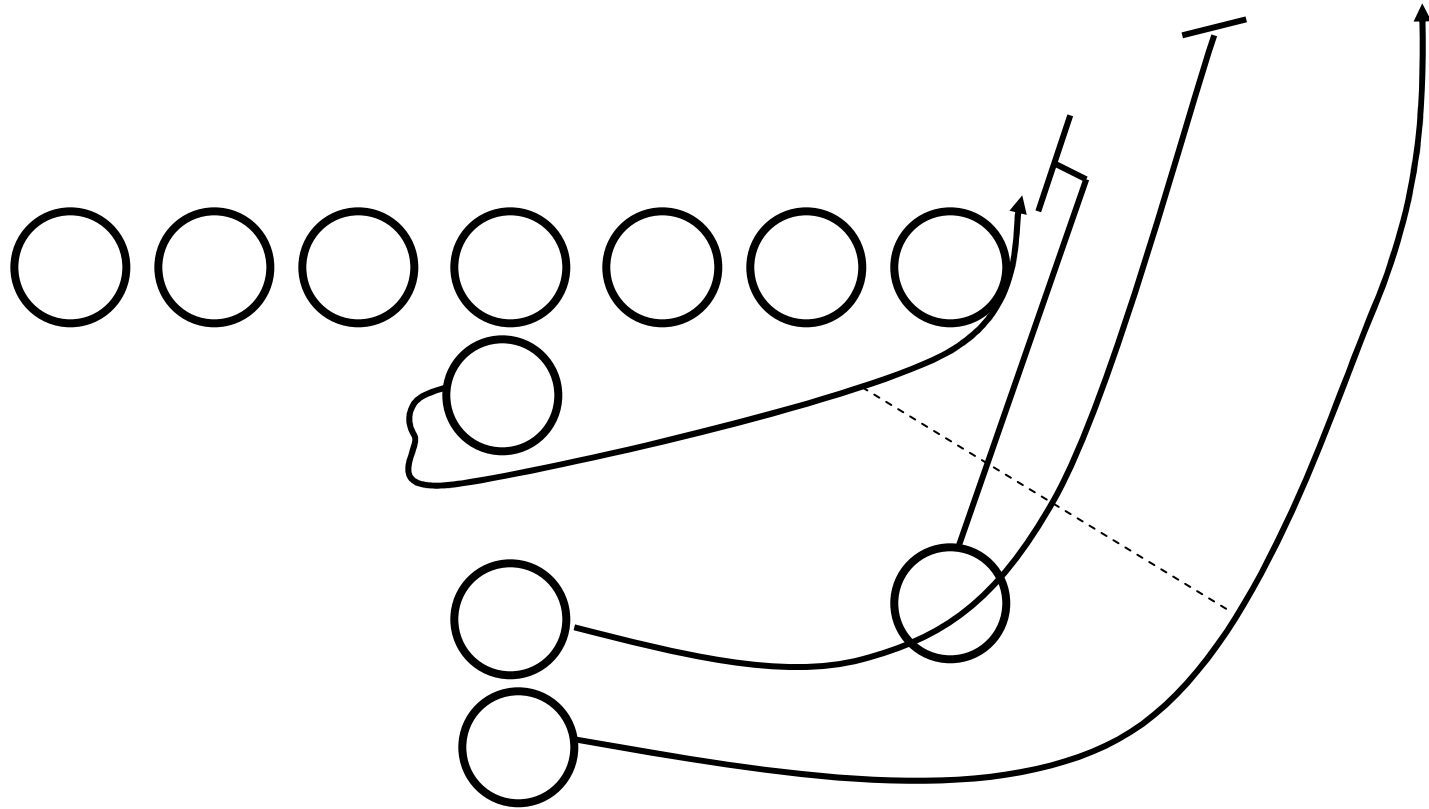

24 Dive

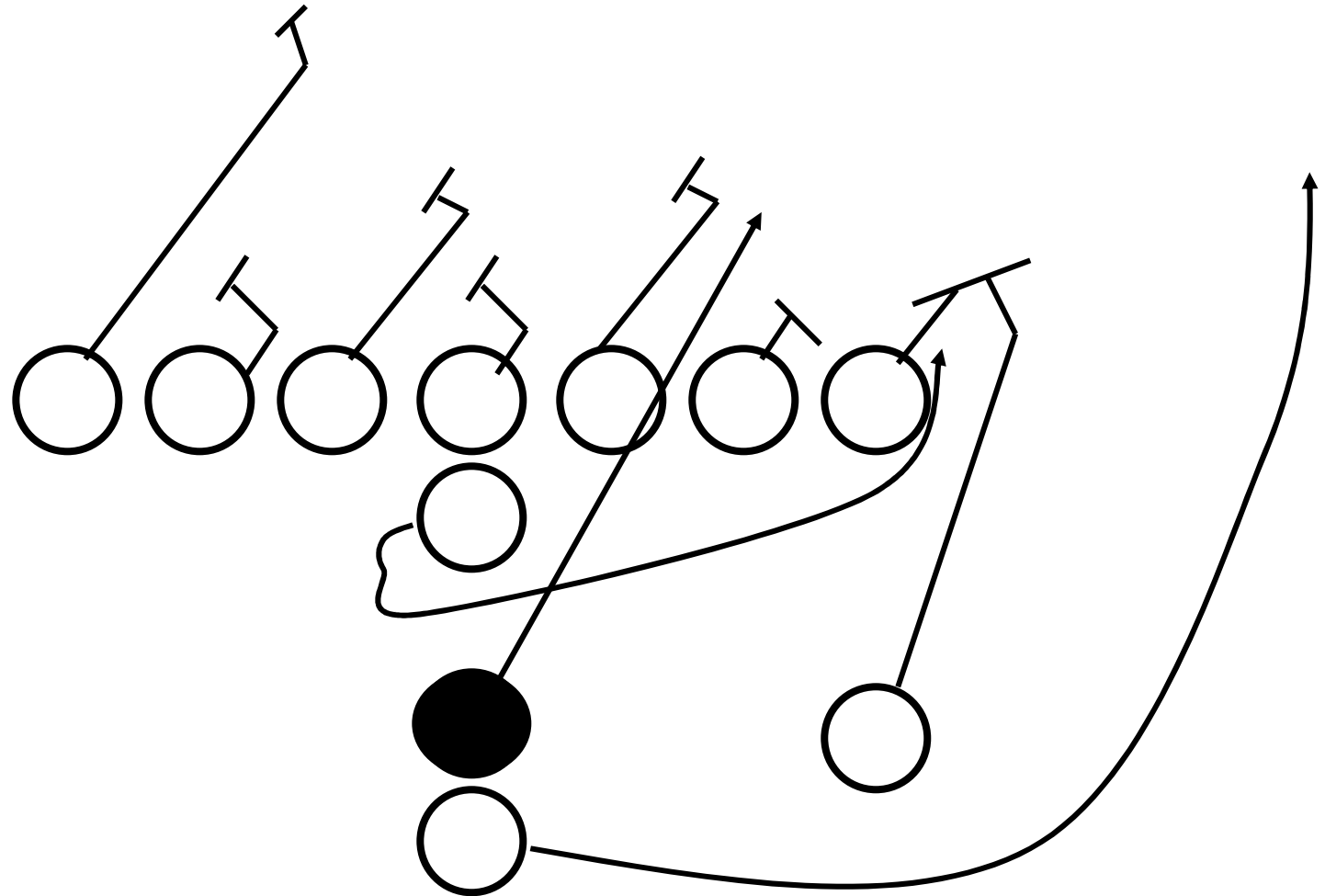

24 Option

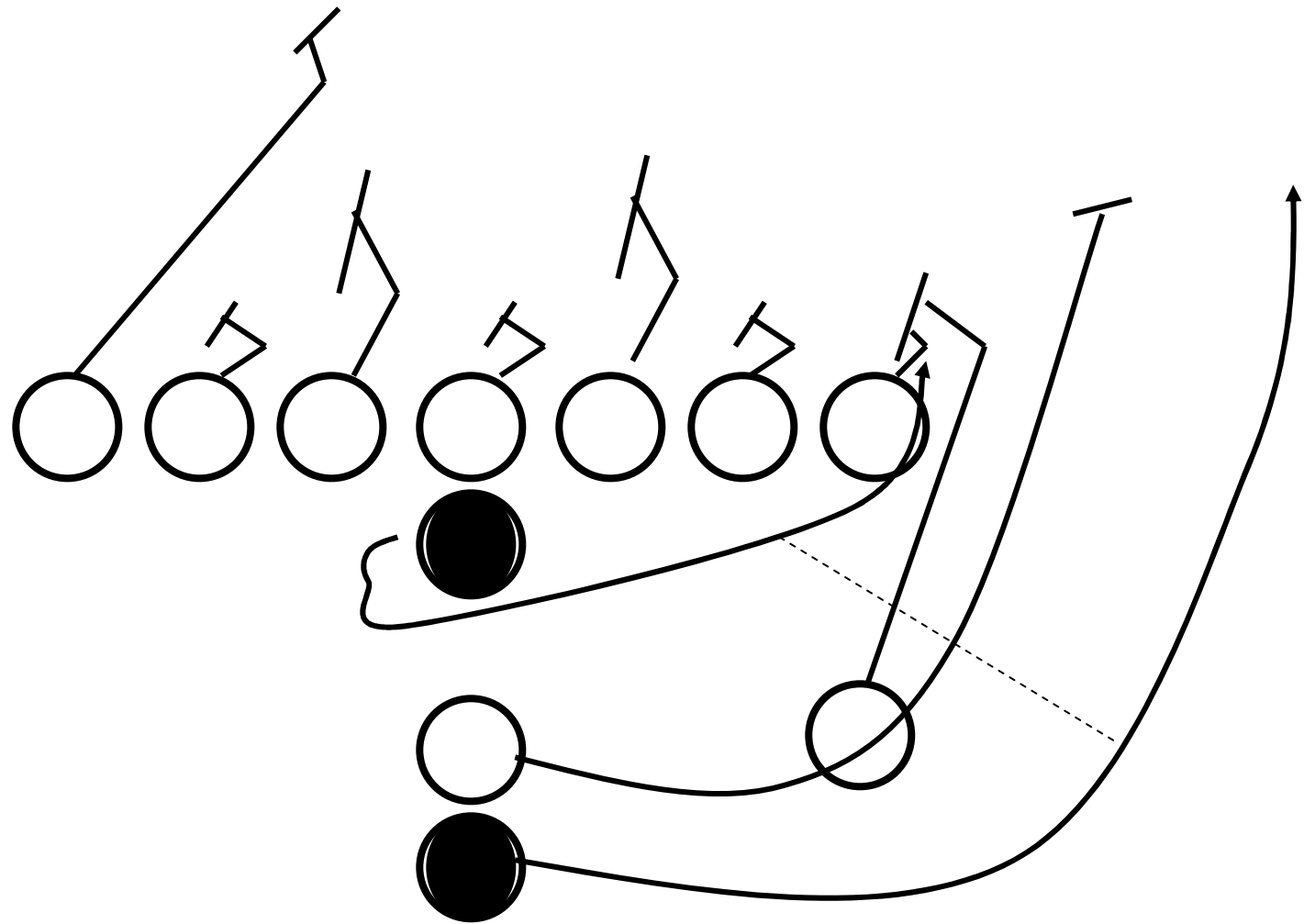

24 Double Reverse

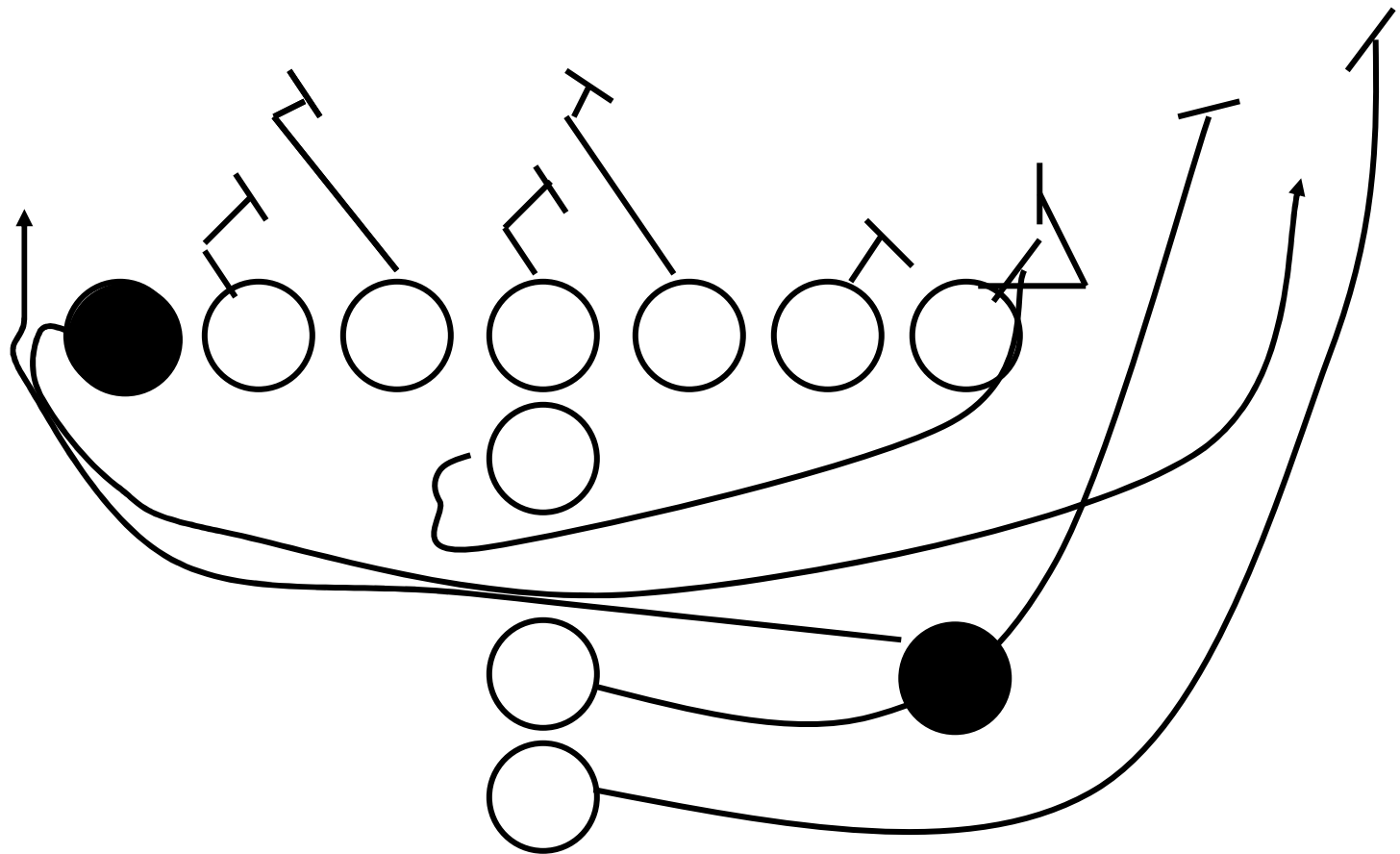

24 Bootleg

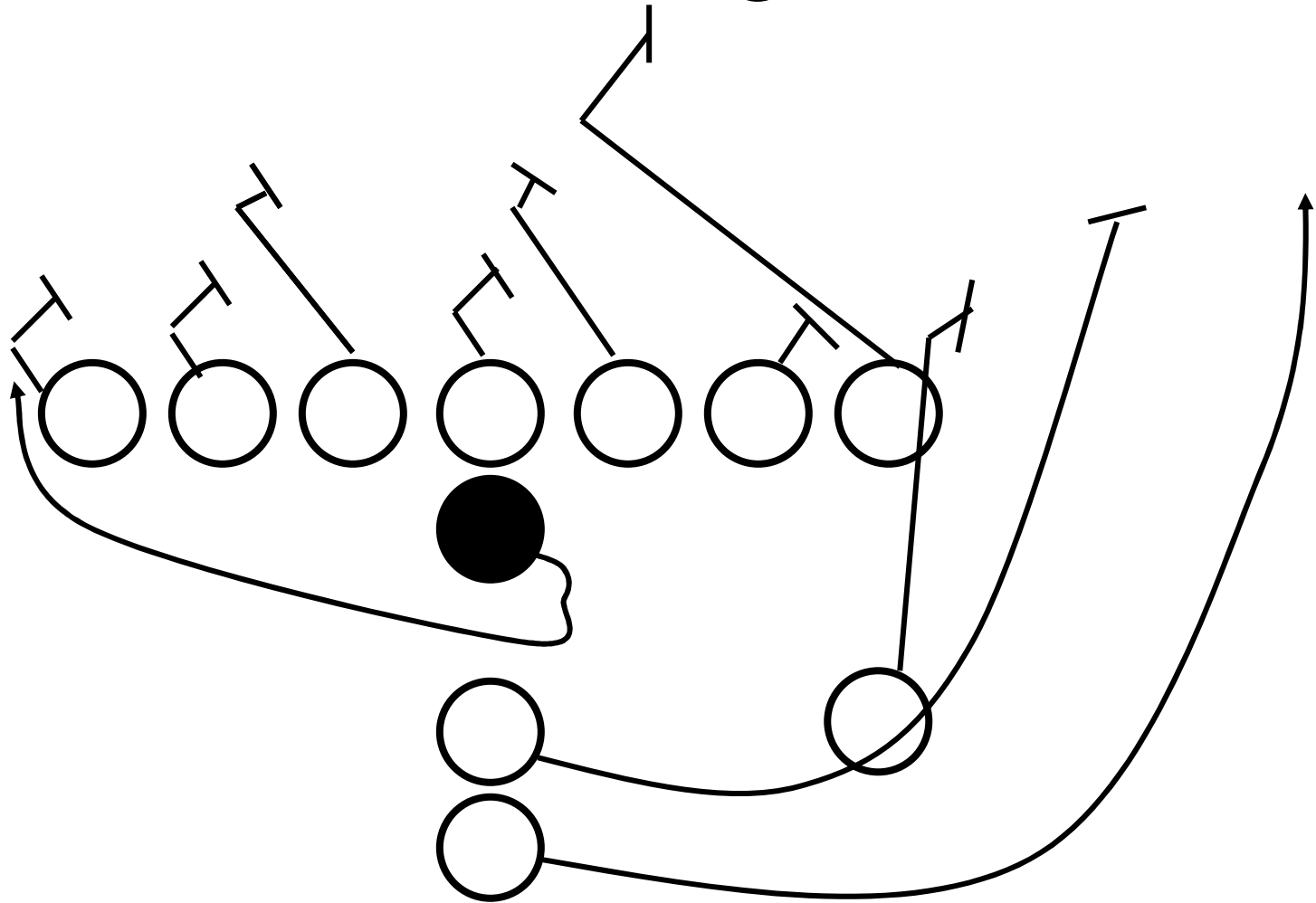

24 Option Pass

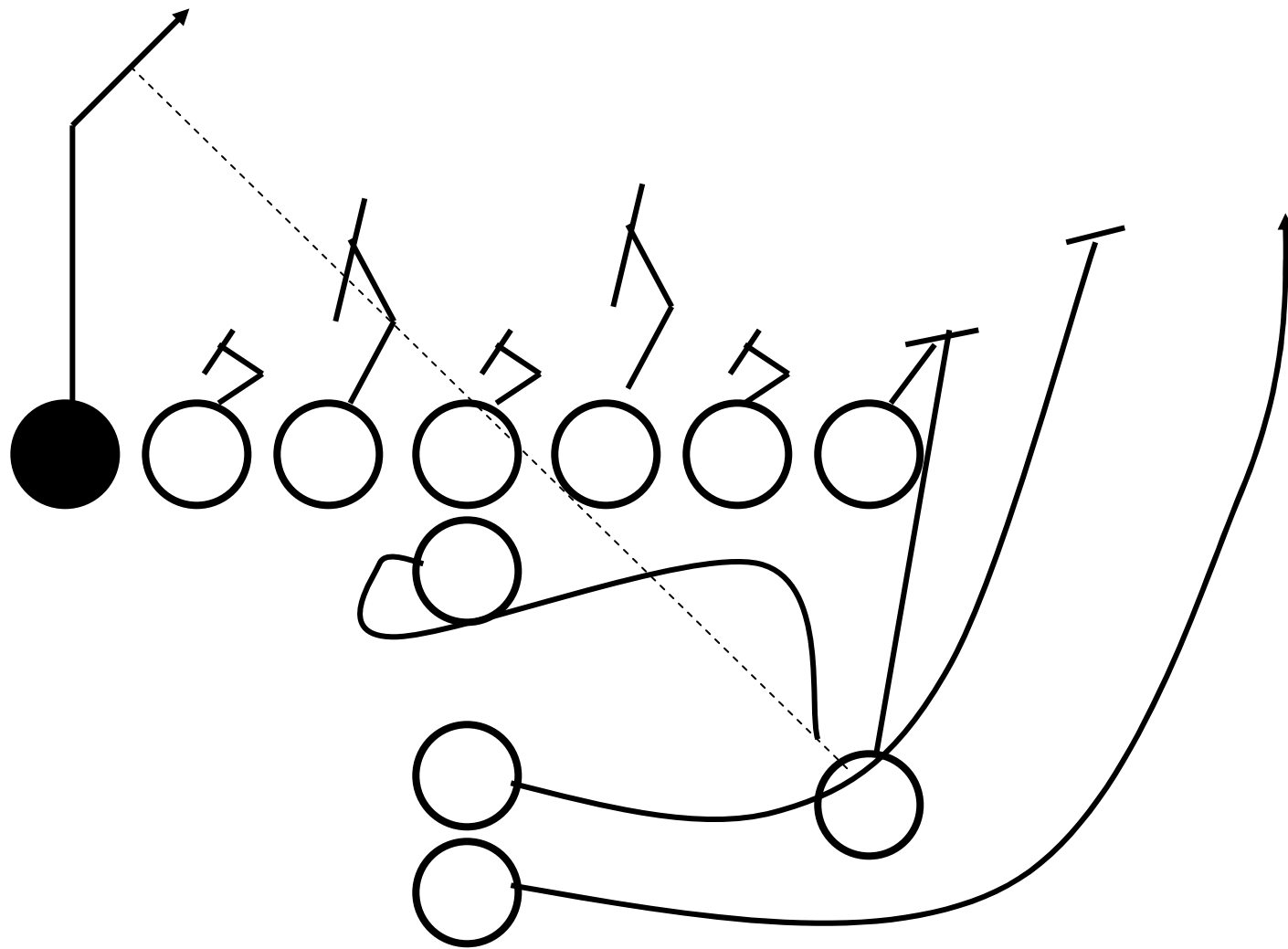

30 Series

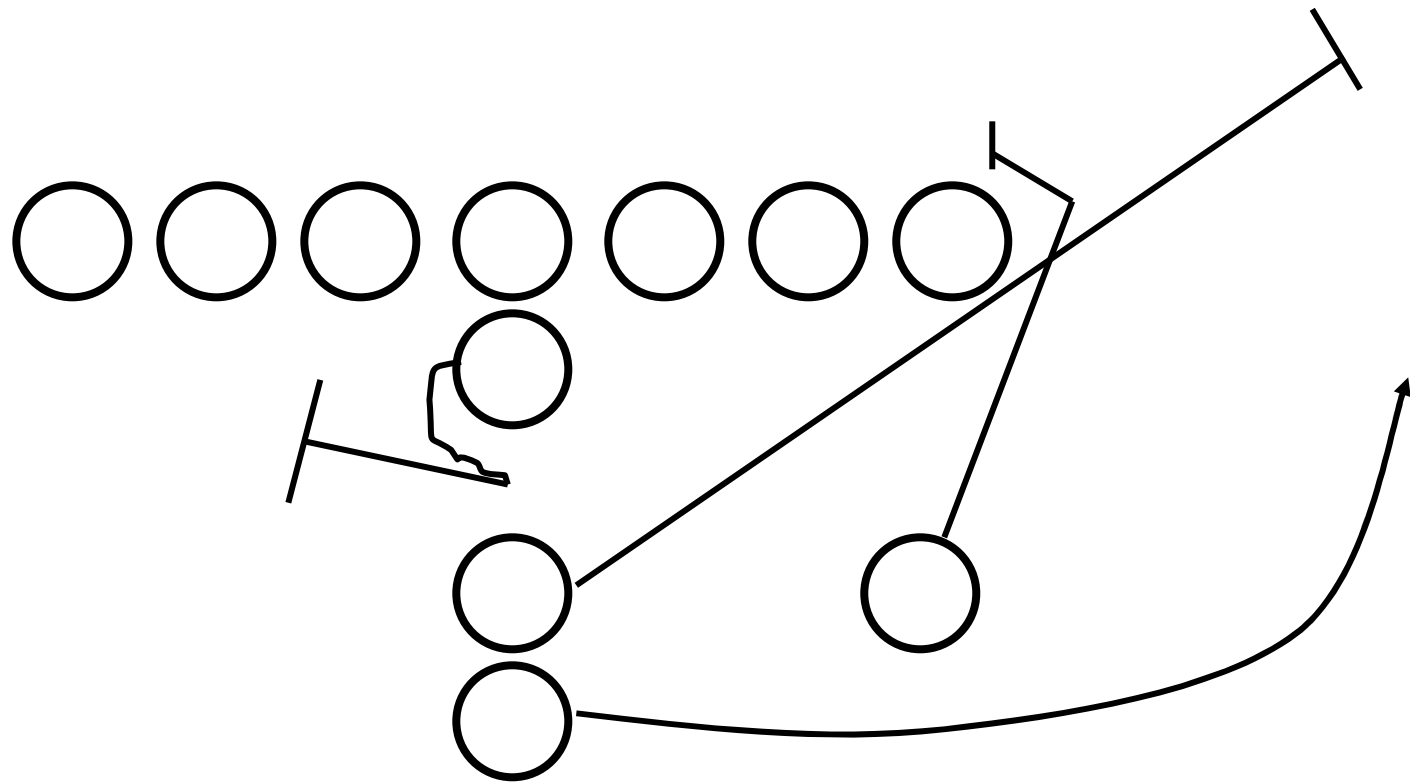

38 Sweep

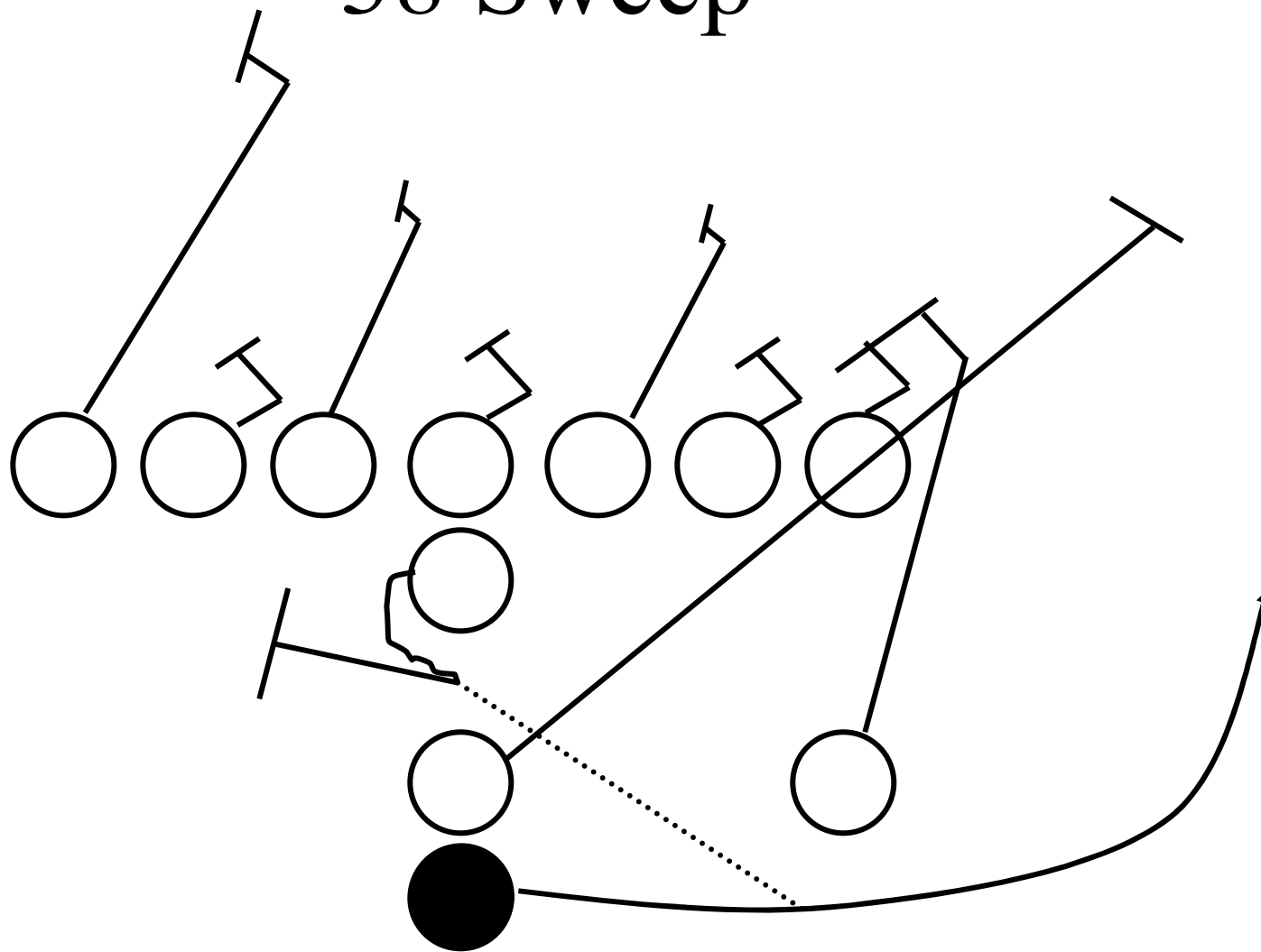

38 Hot Flag

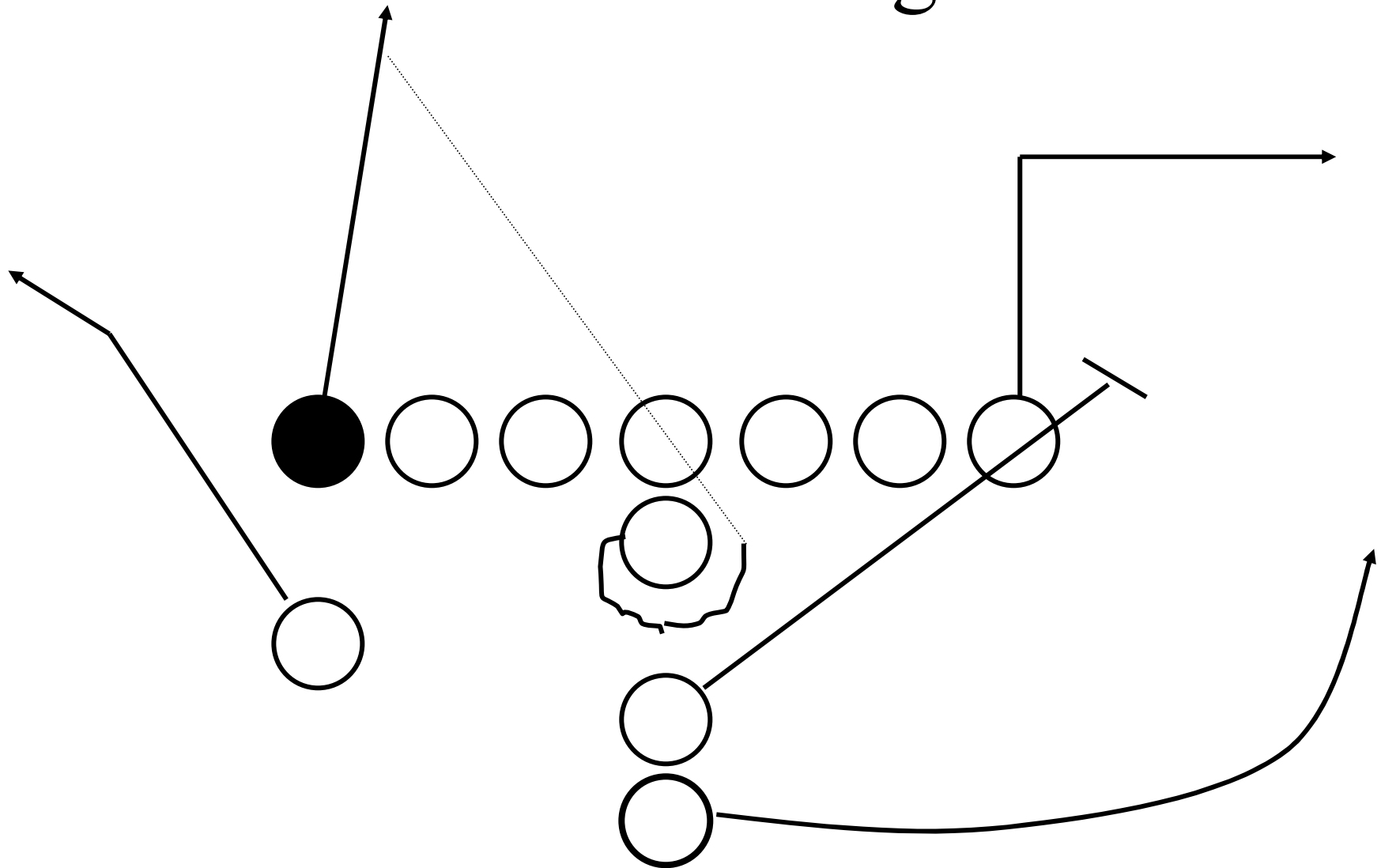

38 Sweep Pass

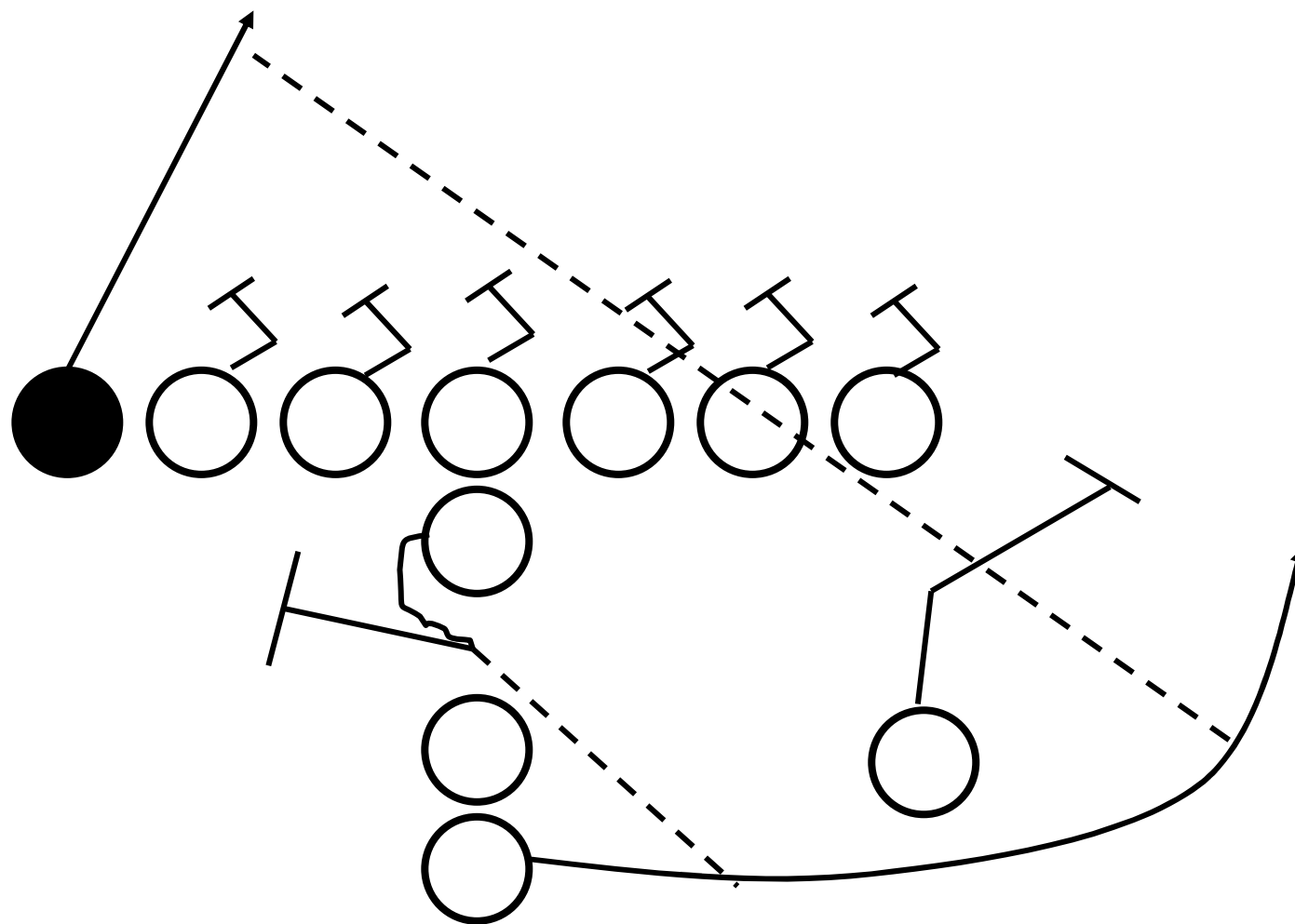

40 Series

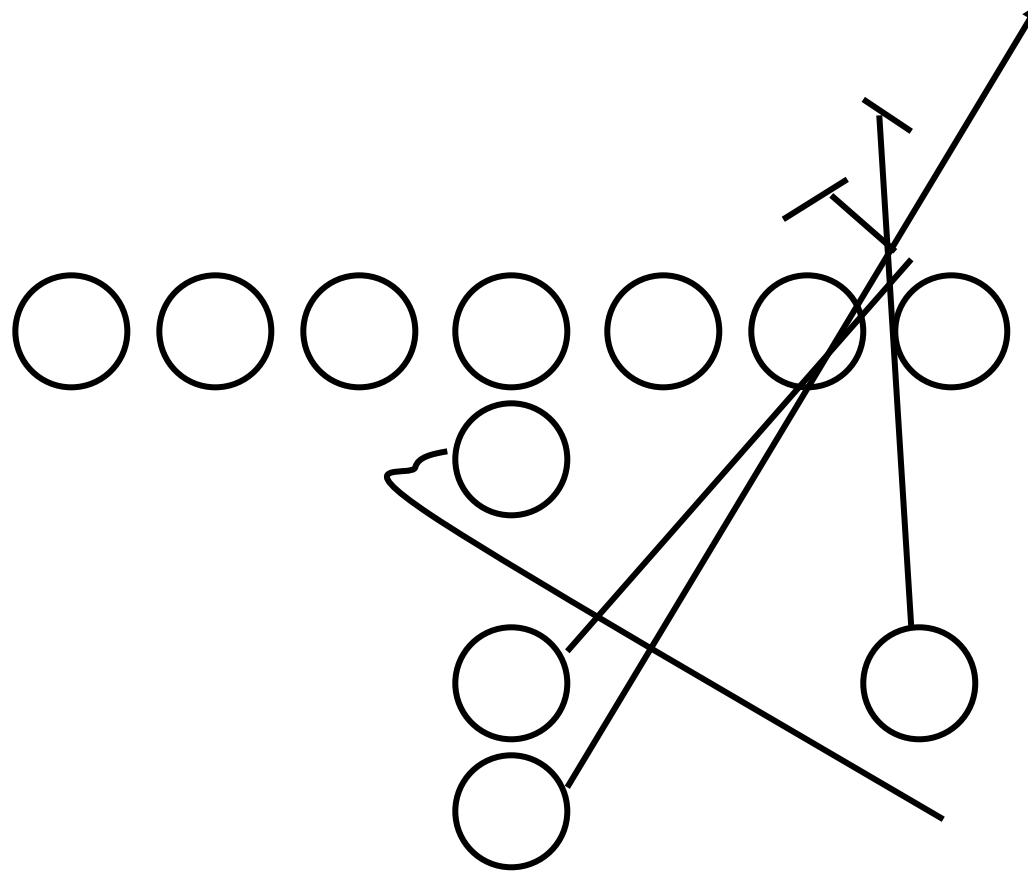

46 Lead

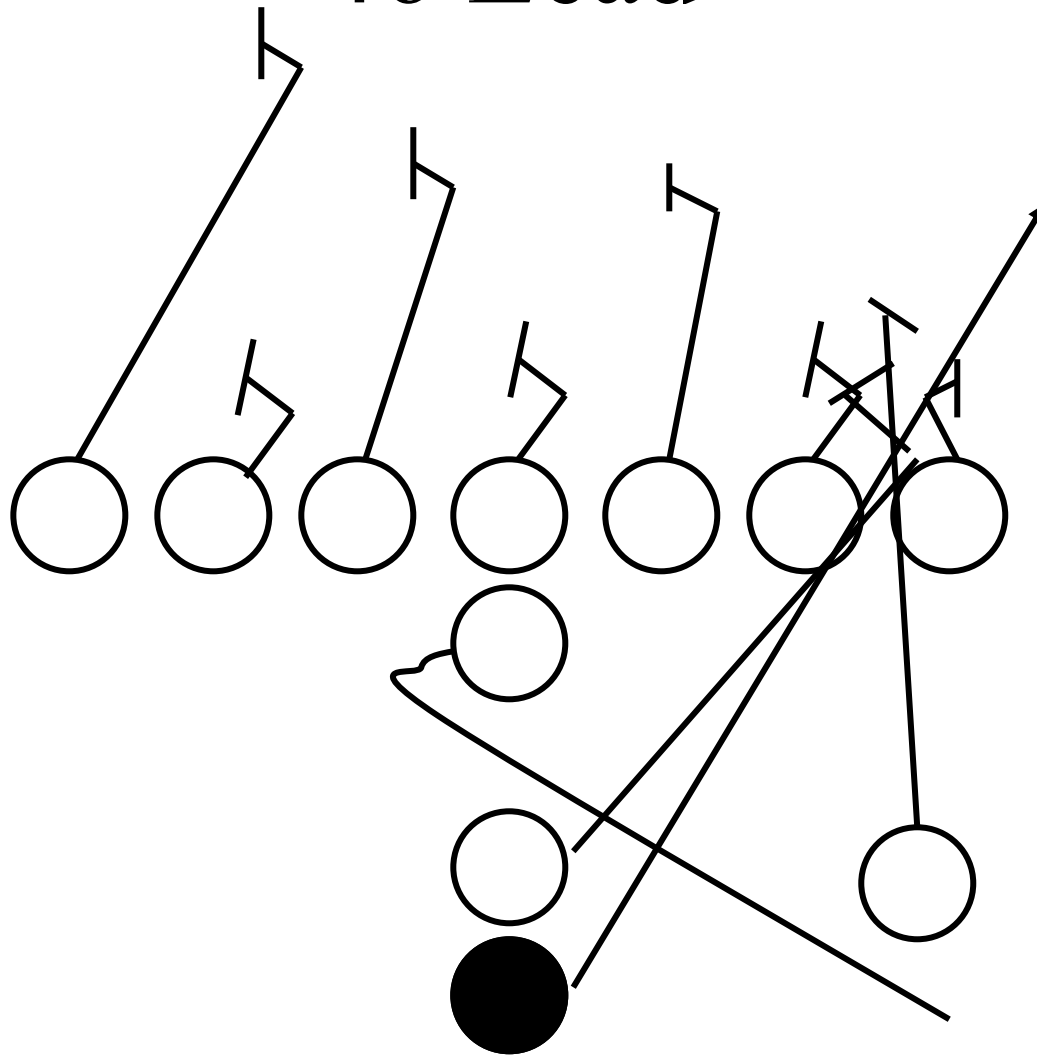

44 Jab

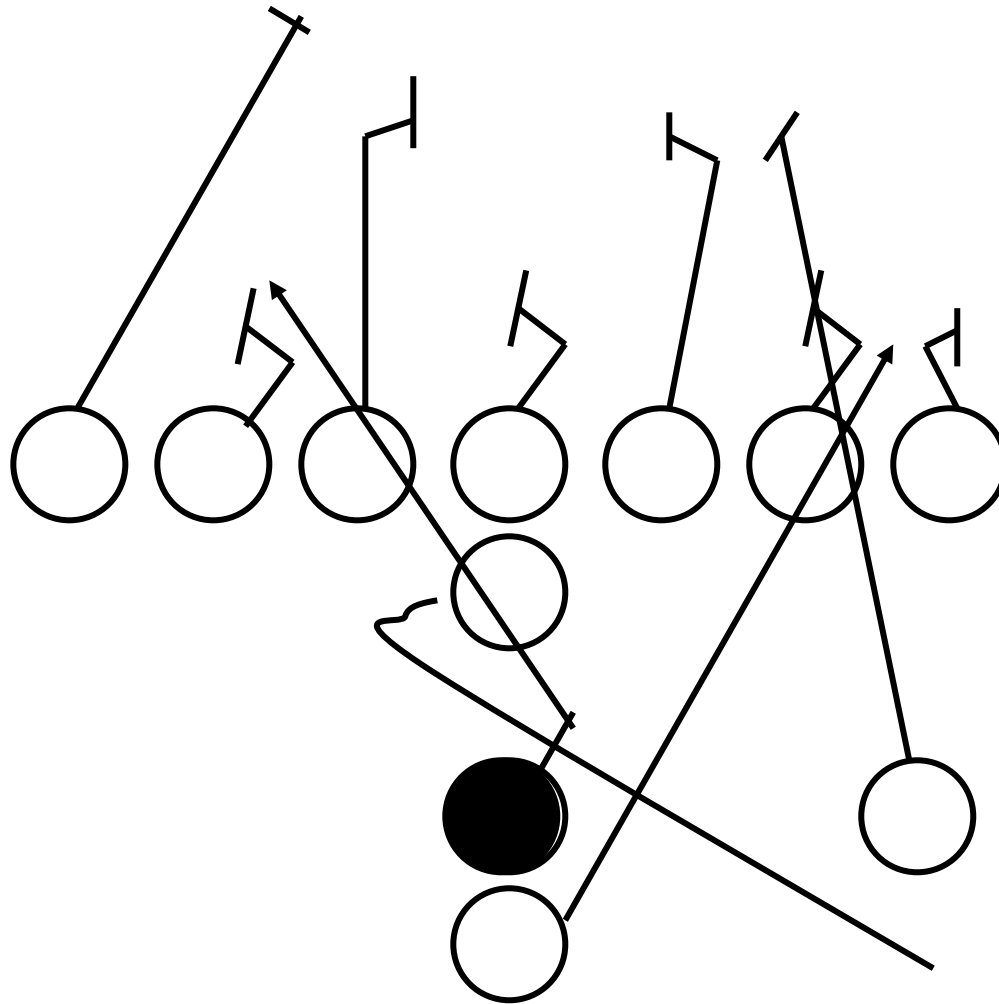

46 Backside Pass

